

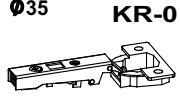









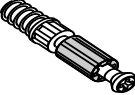
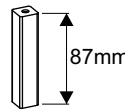
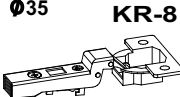



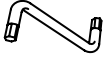

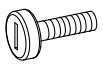

 15x12 12x T02	 4x S10	 Ø35 KR-0 6x Z22	 2x F01
 12x T01	 87mm 2x N07	 Ø35 KR-8 3x Z24	 Ø20 8x C01
 8x28 16x D01	 2x S11	 3,5x16 18x W01	 Z3 1x K02
 Z4 1x K03	 2x N08	 3x S42	 3x L6
 7x50 4x W15	 M5-20 6x NS1	 4x25 6x W28	
 12x E01	 4x16 24x W25	 2x P01	
 6x N05	 24x R01	 4x13 4x W07	
 97mm 4x N06	 9x Z21	 5x70 2x F11	

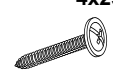

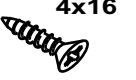
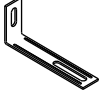
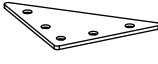
NR	DIM	QTE	COLLI
1	757x402x15	1	2/2
2	739x401x18	1	1/2
3	739x401x18	1	1/2
4	757x402x15	1	2/2
5	1550x420x18	1	2/2
6	493x373x15	2	2/2
7	499x373x15	1	2/2
8	1518x401x18	1	2/2
9	512x751x15	1	1/2
10	512x751x15	1	1/2
11	512x751x15	1	1/2
12	757x507x2	3	1/2

0 10 20 30 40 50 60 70 80 90 100 110 120 130 140 150 160 170 180 190 200

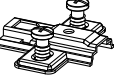

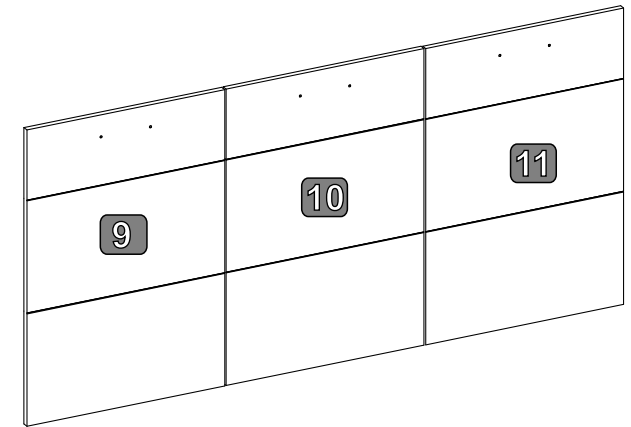
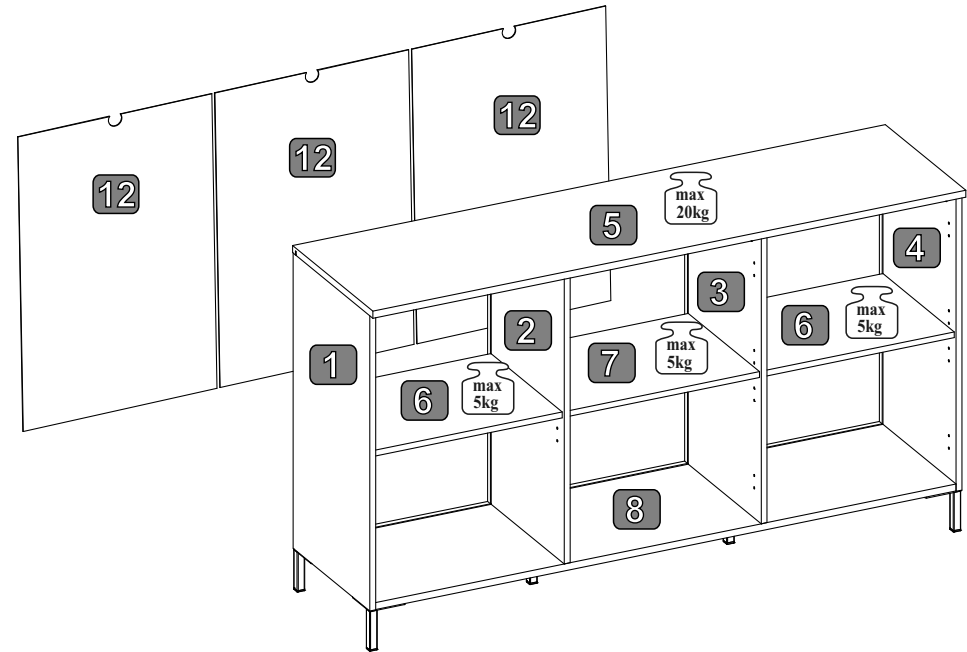

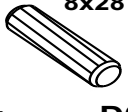
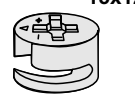
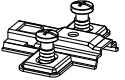
1

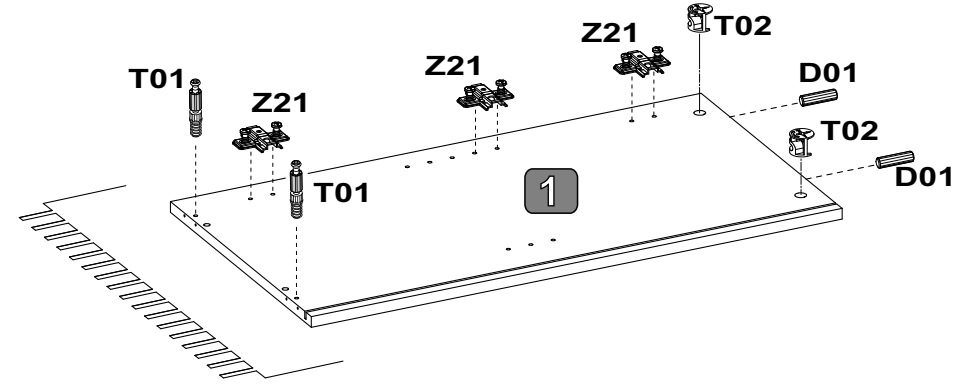
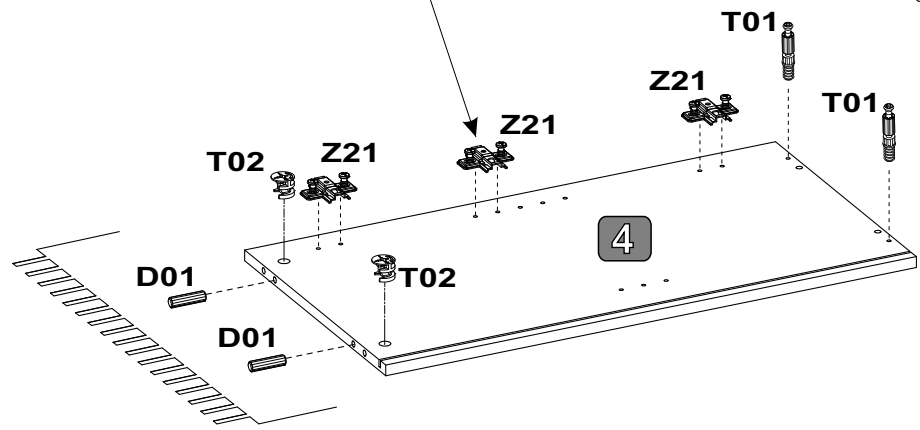
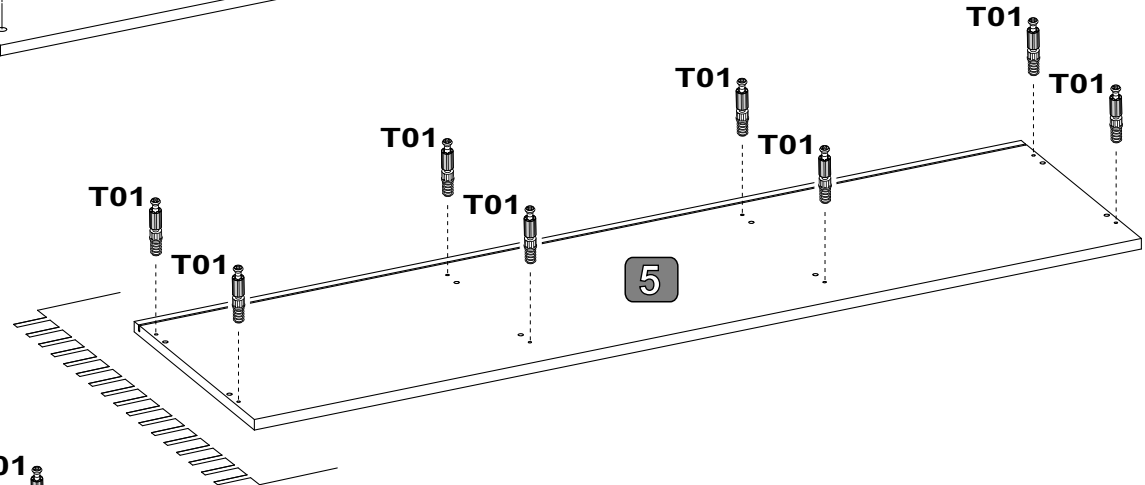
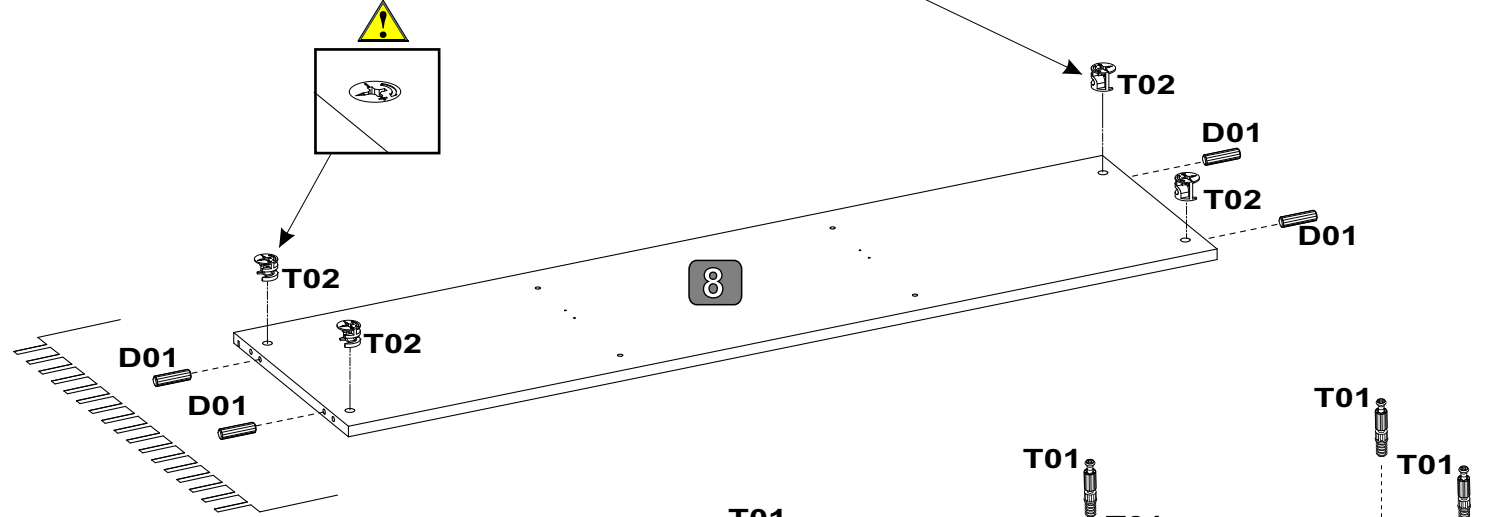
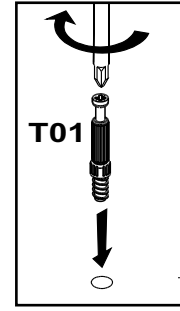
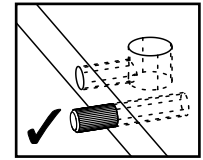
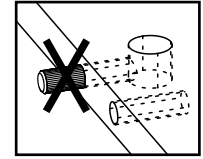
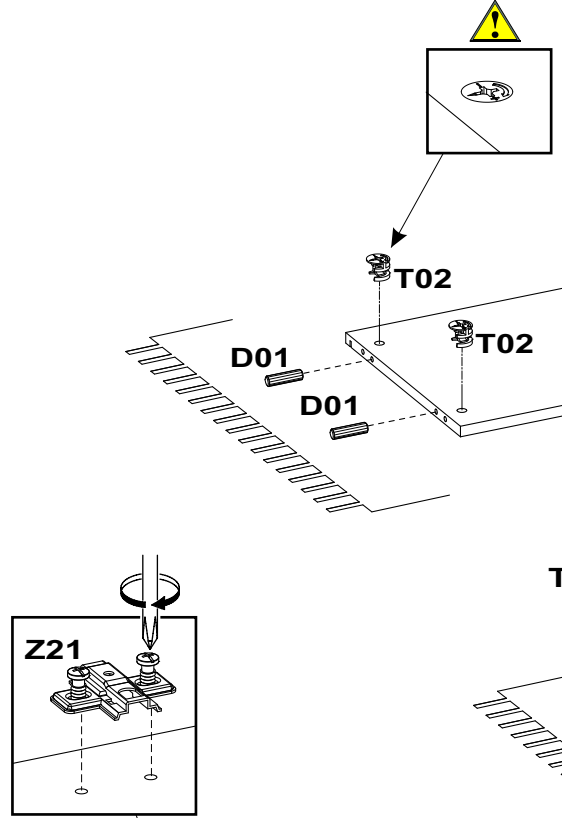
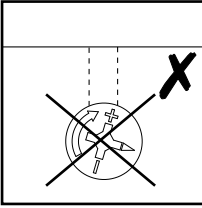
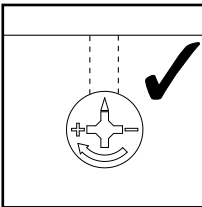
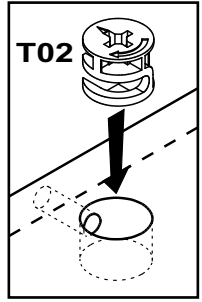
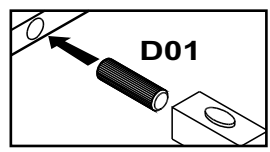
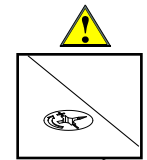
8x28 	15x12 	
8x D01	12x T01	8x T02 6x Z21



2

8x28 	15x12 	
8x D01	4x T02	3x Z21

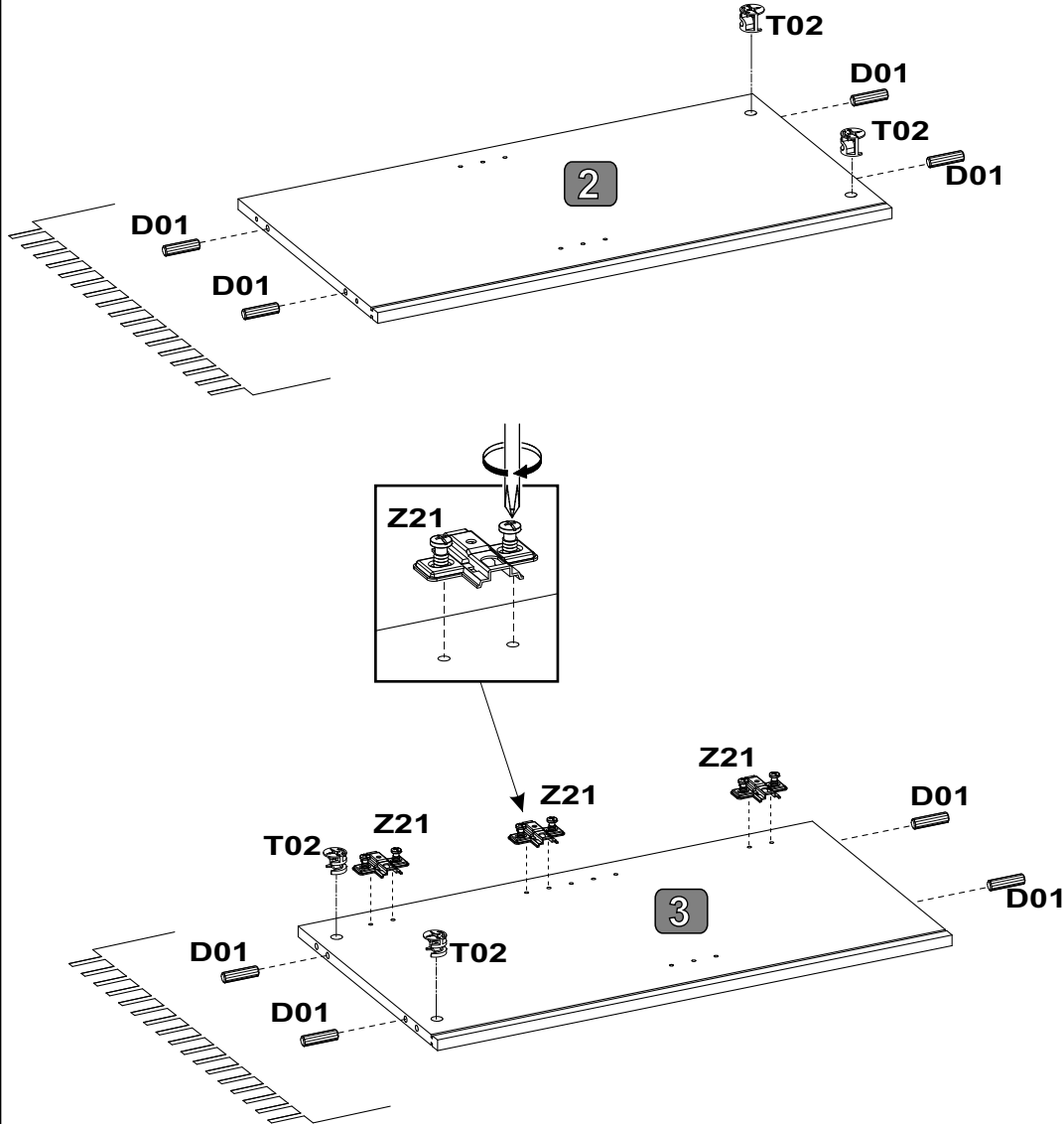

3

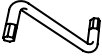
7x50 	Z4 
4x W15	1x K03

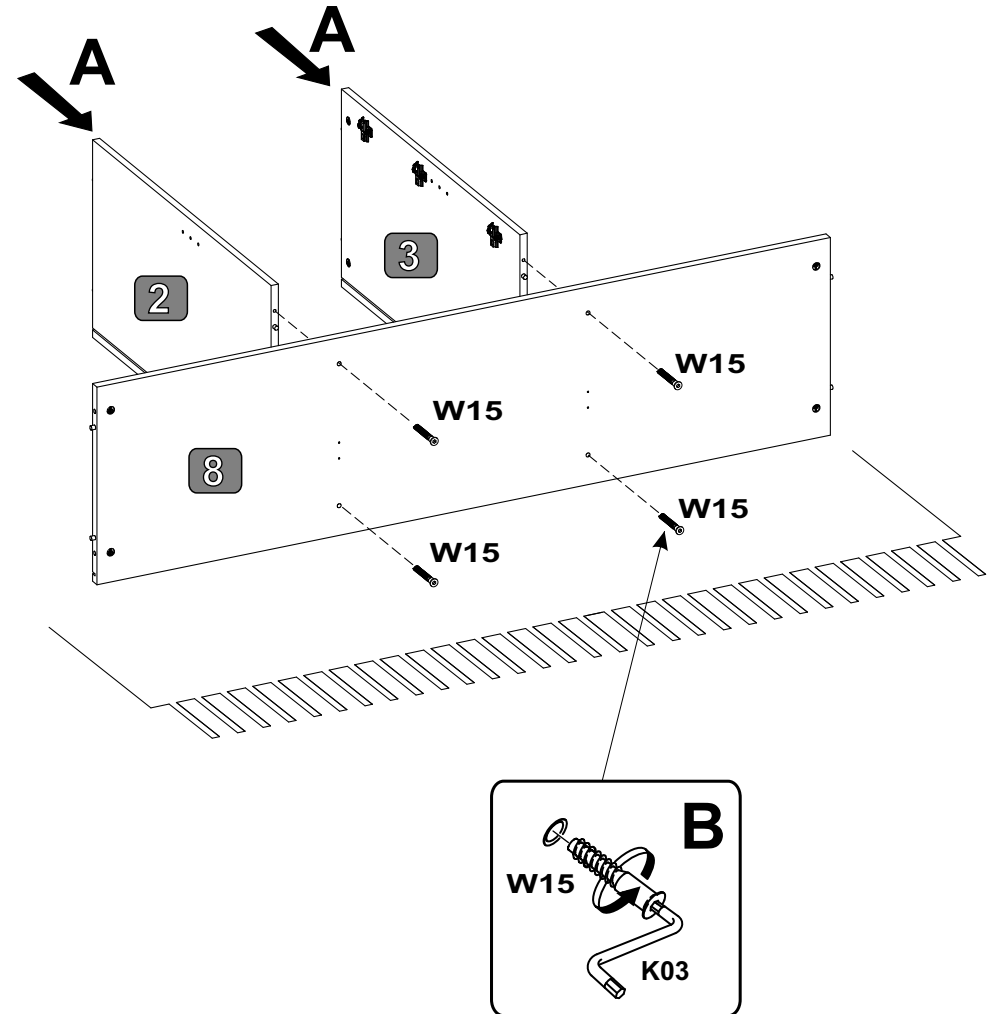

4

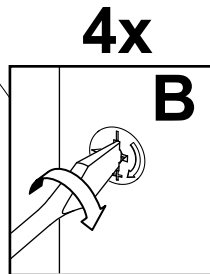
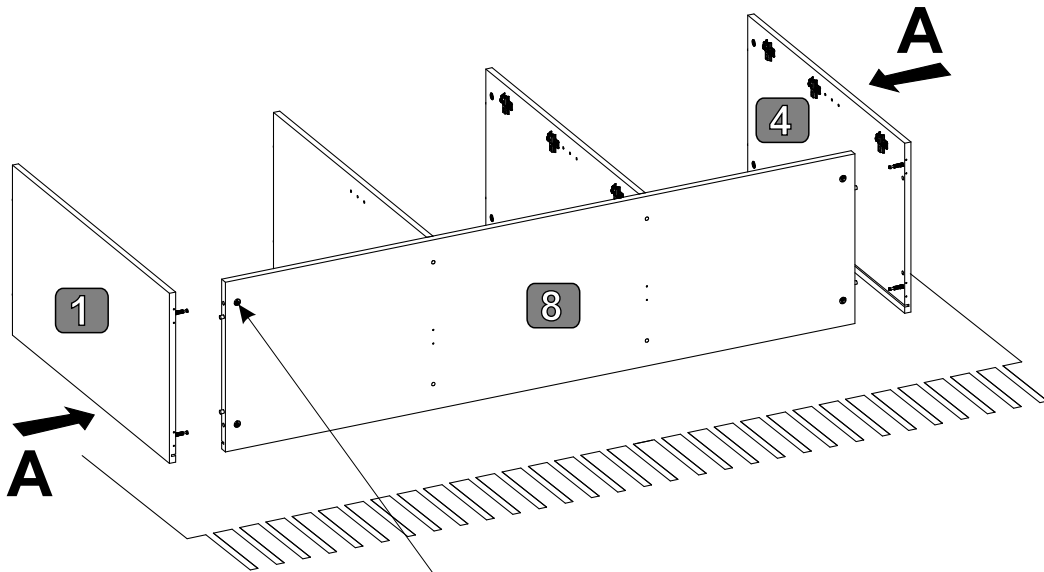

5

4x N06	97mm 	4x S10		4x NS1	M5-20 	4x N05	
1x K02	Z3 	16x W25	4x16 				

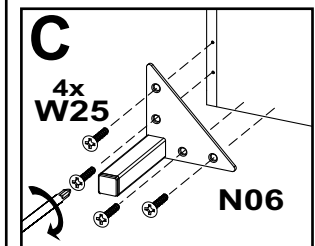
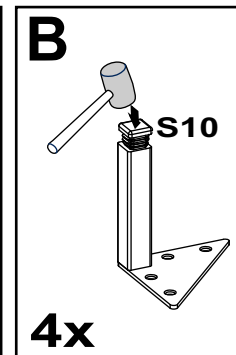
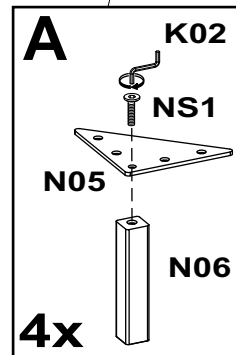
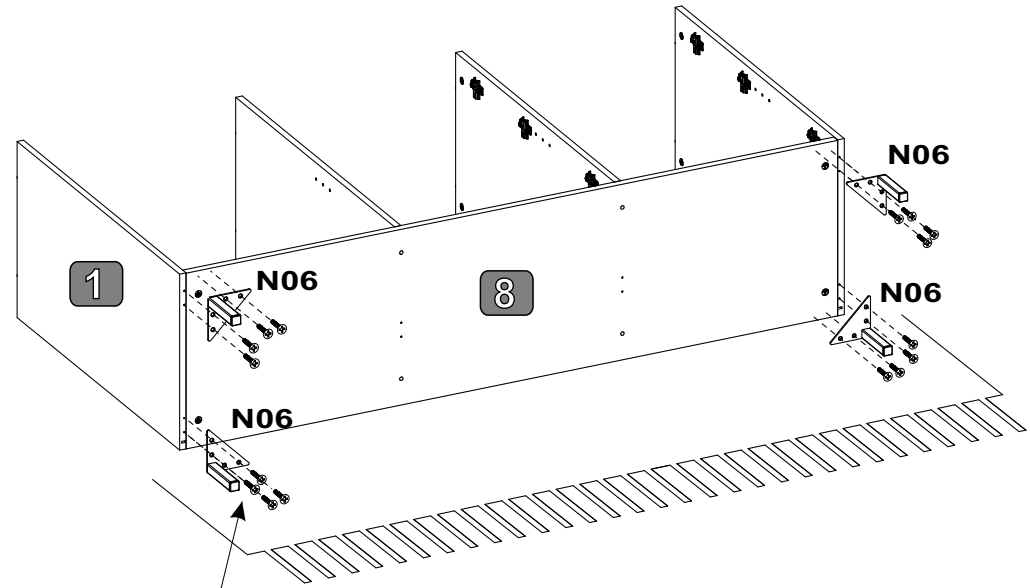

6

2x N07	2x S11	2x NS1	2x N05	1x K02
			2x N08	8x W25

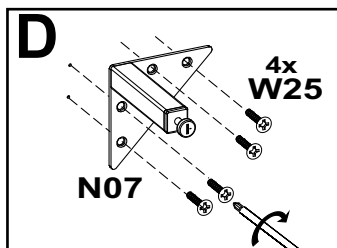
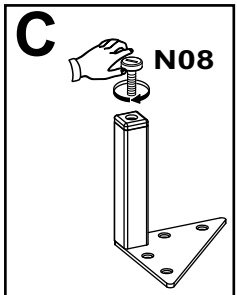
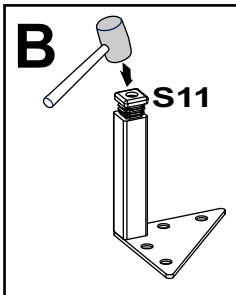
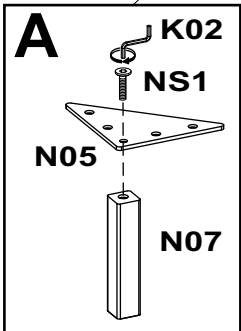
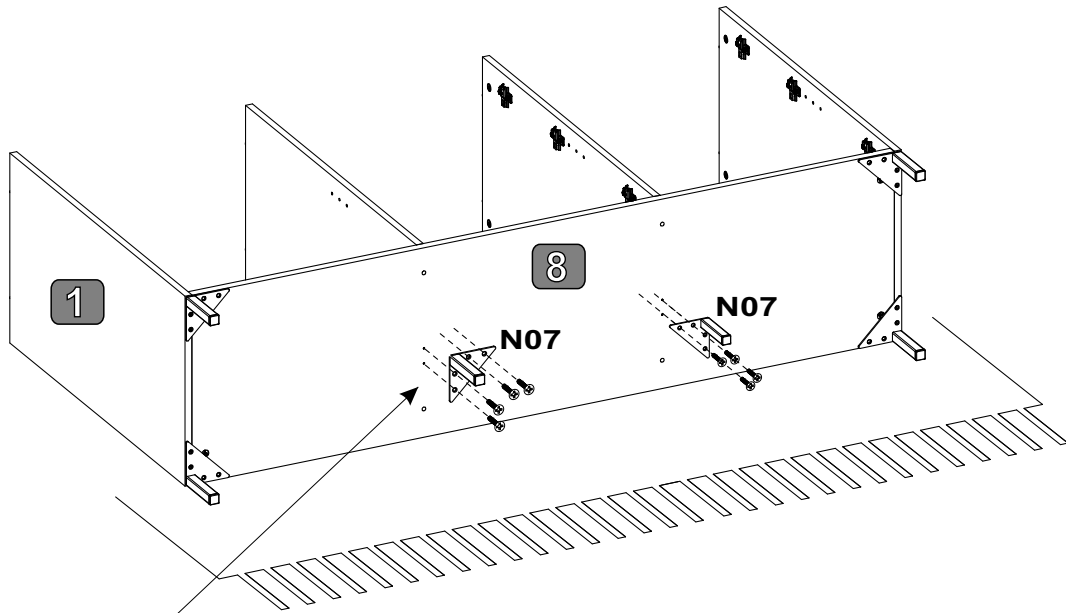

7

8x C01

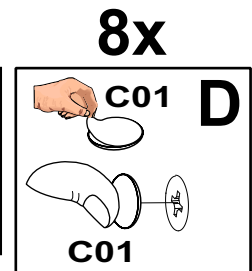
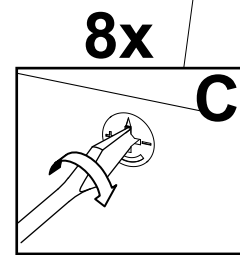
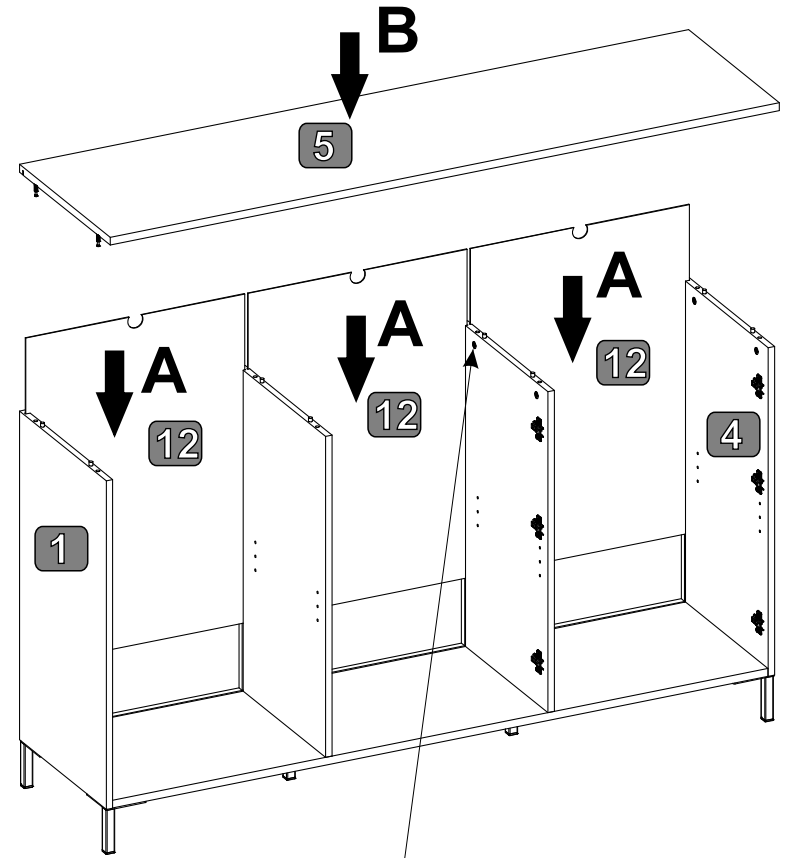

8

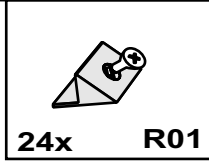

a=b

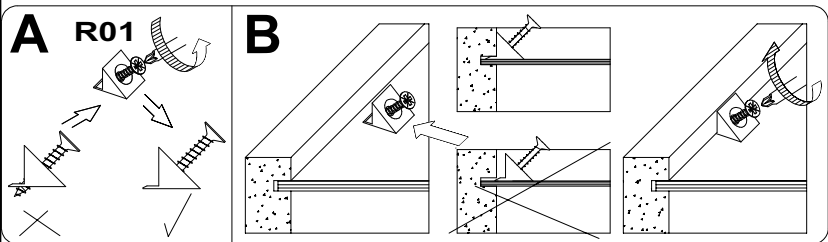
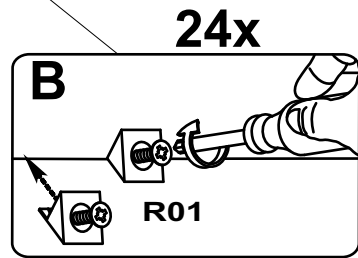
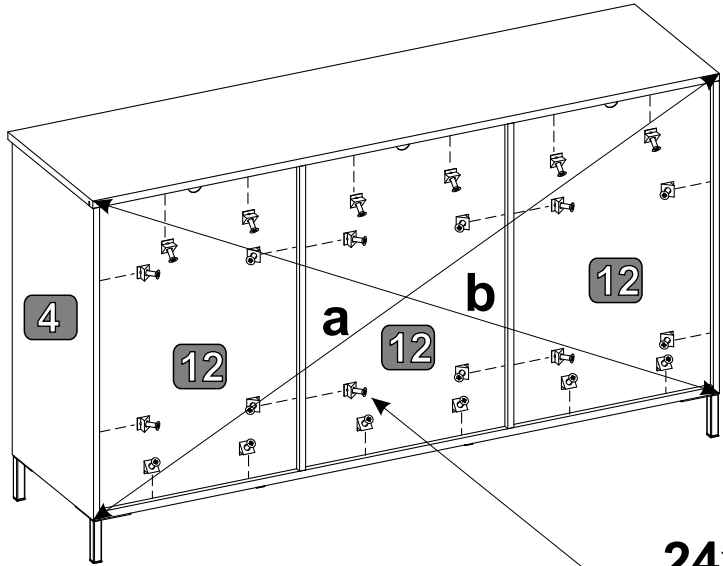
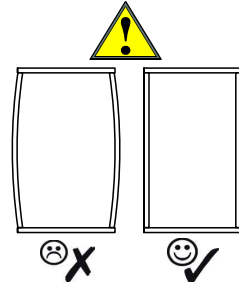

9

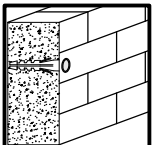
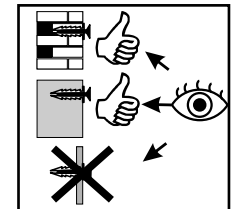
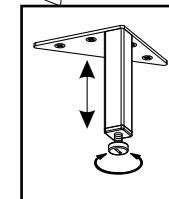
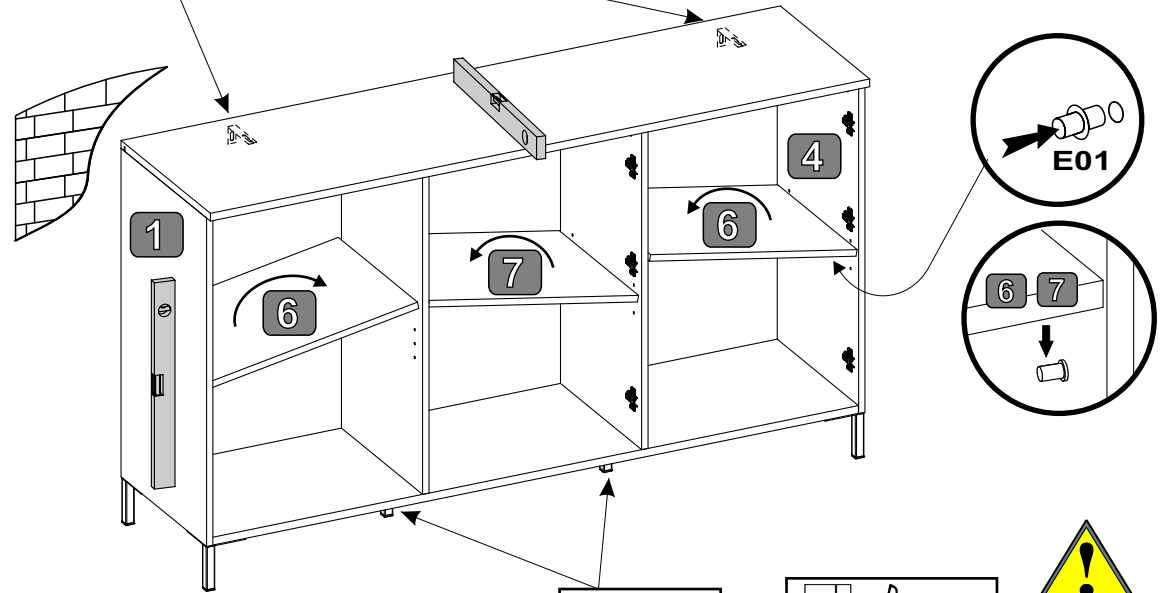
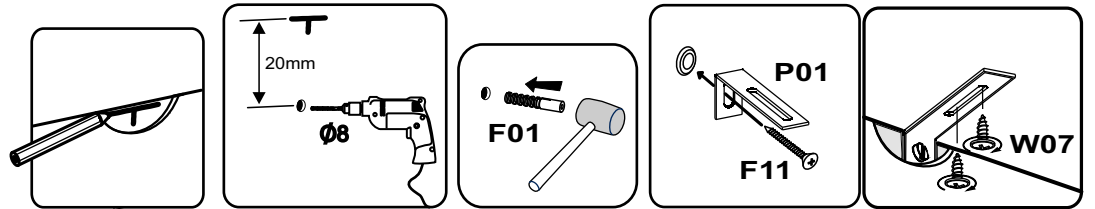
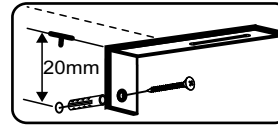
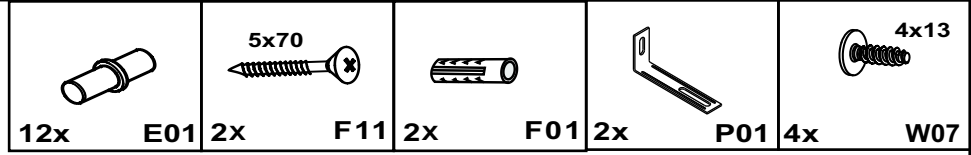

10

Ø35

KR-8

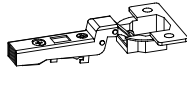

3x Z24

3,5x16

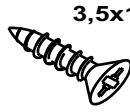

6x W01



1x L6



Ø35 KR-8

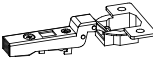

3x Z24

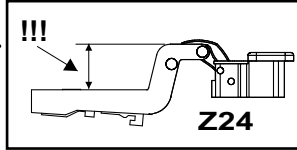

X

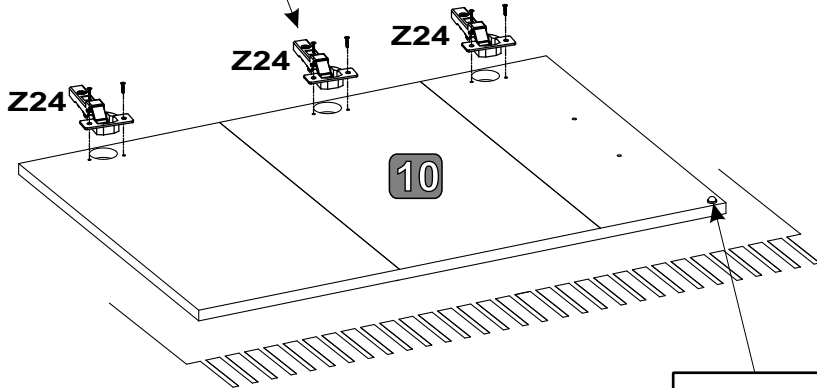
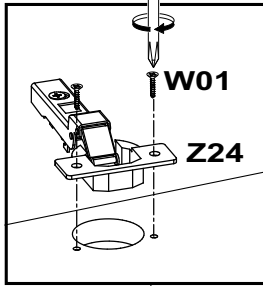
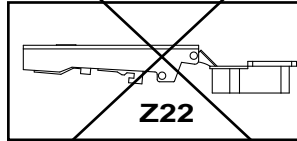

10

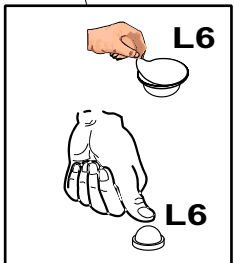

11

Ø35

KR-0

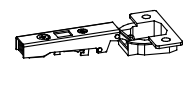

6x Z22

3,5x16

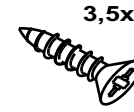

12x W01



2x L6

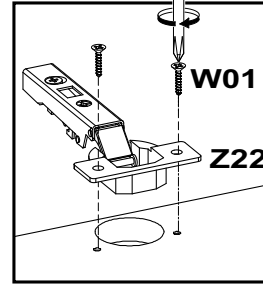

x3

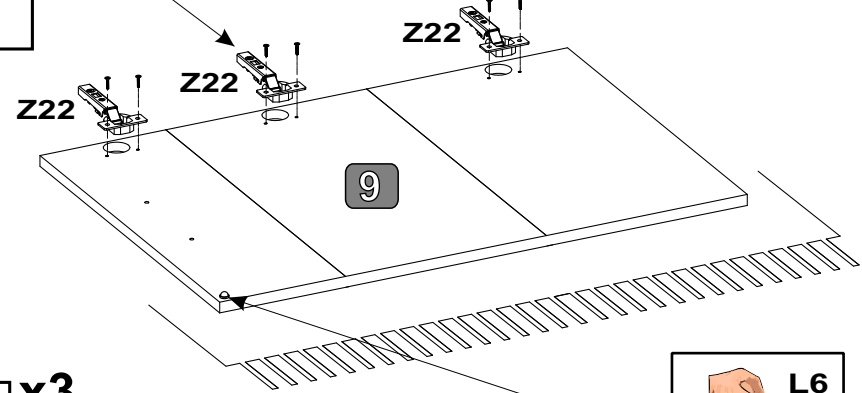

9

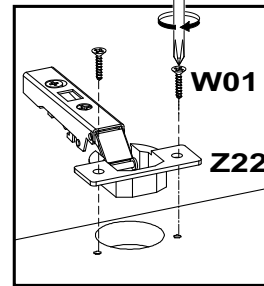

x3

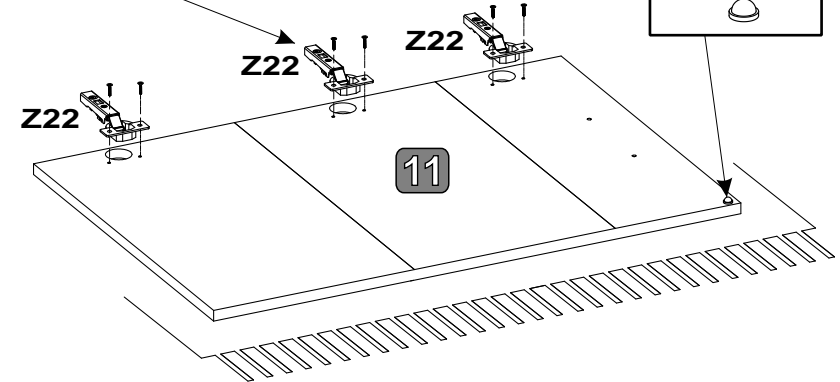

11

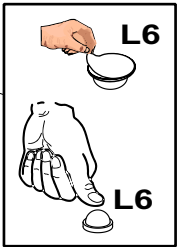

12

